

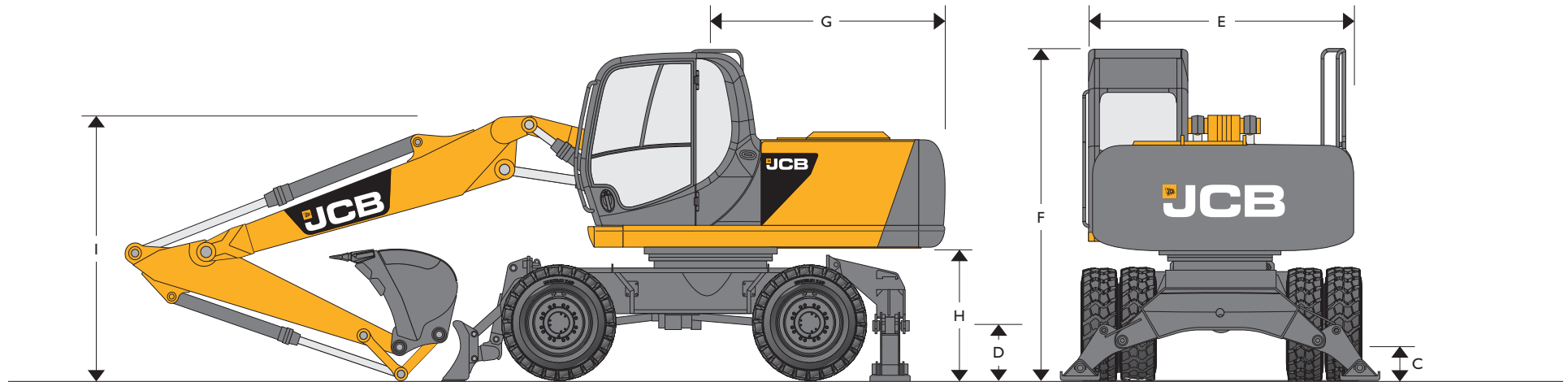

MAX. OPERATING WEIGHT: 18120 kg (39948 lb) ENGINE POWER: 128 kW (172 hp)



### STATIC DIMENSIONS

Dimensions in millimetres (ft-in)	
A	Internal width between dual wheels 1330 (4-4)
B	External width between dual wheels 2490 (8-2)
C	Ground clearance 350 (1-1)
D	Height to axle centre line dual wheels 498 (1-7)
	Height to axle centre line single wheels 519 (1-8)
E	Overall width (handrail removed) 2480 (8-2)
F	Height over cab 3195 (10-6)
G	Tail length 2330 (7-8)
H	Clearance under counterweight 1270 (4-2)

#### Monoboom

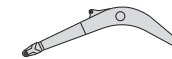

Dipper length		2.25m (7ft 5in)	2.70m (8ft 10in)	3.05m (10ft 0in)
I	Transport boom height mm (ft-in)	2765 (9-1)	2765 (9-1)	3240 (10-7)
J	Transport length mm (ft-in)	8285 (27-2)	8275 (27-2)	8446 (27-8)

#### Triple articulated boom

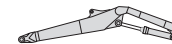

Dipper length		2.25m (7ft 5in)	2.70m (8ft 10in)	3.05m (10ft 0in)
I	Transport boom height mm (ft-in)	2806 (9-2)	2874 (9-5)	3136 (10-3)
J	Transport length mm (ft-in)	8263 (27-1)	8258 (27-1)	8223 (27-0)

## CHASSIS OPTIONS

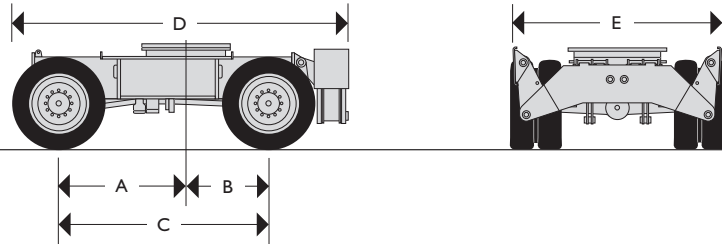

## Dimensions in millimetres (ft-in)

A	Centre of slew ring to front axle	1500 (4-11)
B	Centre of slew ring to rear axle	1000 (3-3)
C	Wheelbase	2500 (8-2)
D	Length including rear stabilizers	3950 (12-11)
E	Width over stabilizers (raised)	2480 (8-1)

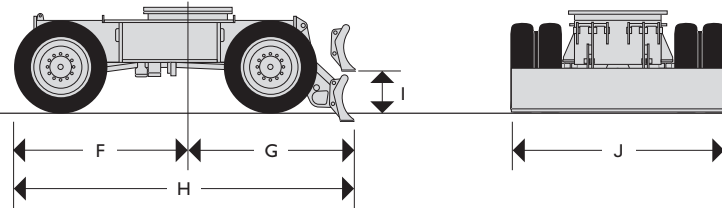

## Dimensions in millimetres (ft-in)

F	Centre of slew ring to face of front tyre	1990 (6-6)
G	Centre of slew ring to rear dozer blade (lowered)	2090 (6-10)
H	Length including rear dozer blade (raised)	4050 (13-3)
I	Ground level to bottom of rear dozer blade (raised)	450 (1-6)
J	Dozer blade width	2480 (8-1)

## CHASSIS OPTIONS

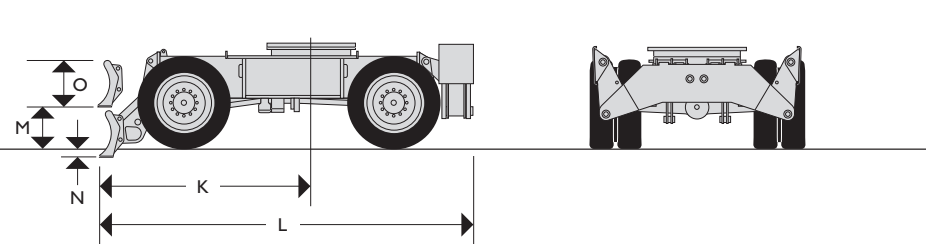

## Dimensions in millimetres (ft-in)

K	Centre of slew ring to front dozer blade (lowered)	2530 (8-3)
L	Length including stabilizers and dozer blade (raised)	4460 (14-7)
M	Ground level to bottom of front dozer blade (raised)	450 (1-6)
N	Dozer blade dig depth	130 (0-5)
O	Dozer blade height	500 (1-8)

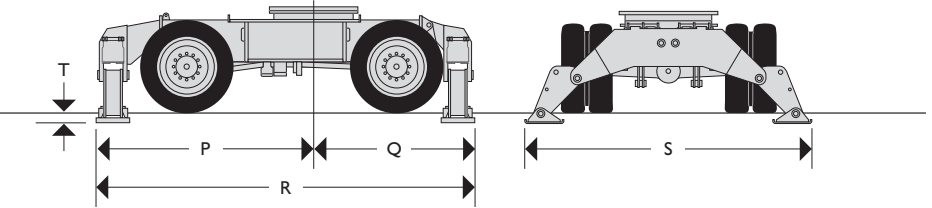

## Dimensions in millimetres (ft-in)

P	Centre of slew ring to front stabilizers	2520 (8-3)
Q	Centre of slew ring to rear stabilizers	1960 (6-5)
R	Length including front and rear stabilizers	4480 (14-8)
S	Width over stabilizers (lowered)	3550 (11-8)
T	Stabilizer lift height	130 (0-5)



## ENGINE

<b>Model</b>	Isuzu 4HKIX European Tier 3 emission compliant.
<b>Type</b>	Watercooled, 4-stroke, 4-cylinder in-line, direct injection, turbocharged diesel.
<b>Nett power (ISO 3046-1NF)</b>	128kW (172hp) @ 2000rpm.
<b>Piston Displacement</b>	5.193 litres.
<b>Injection</b>	Electrical governor.
<b>Air Filtration</b>	Dry element with secondary safety element and in cab warning indicator.
<b>Cooling</b>	Water cooler via large capacity radiator.
<b>Starting system</b>	24 volt – 4.5kW.
<b>Batteries</b>	2 x 12 volt Heavy Duty.
<b>Alternator</b>	24 volt 40 amp.
<b>Refuelling pump</b>	Electric type.

## CHASSIS

<b>Structure</b>	High strength flanged 'u' section.
<b>Chassis Options:</b>	
<b>Dozer Blade</b>	Front or rear pin mount.
<b>Stabilisers</b>	Front or rear pin mount, independently operable – plus combinations.
<b>Grab Stowage</b>	Heavy duty, pin mounted stowage bar.
<b>Transmission</b>	Hydrostatic drive via piston motor and powershift transmission.
<b>Travel speed</b>	Creep speed 3.8kph (2.4mph) Low ratio 14kph (9mph) High ratio 30kph (19mph)
<b>Drawbar Pull</b>	99.7kN
<b>Axles</b>	Four wheel drive. Front steering axle oscillates for rough ground mobility.
<b>Axle load capacity</b>	32 tonnes
<b>Axle oscillation</b>	+/- 8.5 degrees
<b>Ground clearance</b>	350mm (1ft 2in)
<b>Steering</b>	Fully hydraulic system.
<b>Turning radius</b>	5.45m (17ft 10in)
To outside of tyres	
To outer edge of front mounted dozer blade	6.06m (19ft 10in)
<b>Brakes</b>	All hydraulic, dual circuit brake system.
<b>Parking Brake</b>	Built into the transmission.

## SWING SYSTEM

<b>Drive train</b>	Axial piston motor and planetary reduction final drive.
<b>Swing brake</b>	Hydraulic braking plus automatic spring applied disc type parking brake.
<b>Swing speed</b>	11.3RPM
<b>Swing gear</b>	Large diameter, internally toothed fully sealed grease bath lubricated.
<b>Swing lock</b>	Multi position switchable brake and mechanical lock.

## EXCAVATOR END

Monoboom available along with a choice of dipper lengths to suit the requirements of reach, dig-depth, loadover height, tearouts and site versatility. Reserve strength is built into the fully welded structures for hydraulic hammer and other arduous operations. Fabricated bucket tipping links are provided with a choice of lift points. Strong, durable construction, large cross sections and multi plate fabrications to withstand high stress applications. The 5.15m (16ft 11in) boom is designed to ensure the optimum digging envelope when matched with the three dipper lengths. Low maintenance bronze alloy bushes with graphite plugs are fitted to boom base and boom to dipper pivots resulting in 1000 hour greasing intervals at these points.



## MAIN HYDRAULIC SYSTEM

<b>System</b>	Load-sensed hydraulic system with twin variable flow piston pumps providing flow-on-demand for maximum efficiency.
<b>Main pumps</b>	2 variable displacement axial piston type.
Maximum flow	2 x 156l/min (34 UK gpm)
Main circuit pressure	314 bar (4555 lb/in <sup>2</sup> )
With power boost	343 bar (4975 lb/in <sup>2</sup> )
<b>Servo pump</b>	Gear type
Maximum flow	27 l/min (6 UK gpm)
Servo pressure	40 bar (580 lb/in <sup>2</sup> )
<b>Optional Circuits:</b>	
<b>Hammer</b>	Includes automatic engine speed setting and return filter.
Maximum flow	138 l/min (30 UK gpm)
Maximum pressure	314 (343) bar (4555/4975 lb/in <sup>2</sup> ) (pre-set to 180 bar (2610 lb/in <sup>2</sup> ))
<b>Grab operation</b>	
Maximum flow	138 l/min (30 UK gpm)
Maximum pressure for grab ram operation	314 (343) bar (4555/4975 lb/in <sup>2</sup> )
<b>Low Flow Pipework</b>	Two options available, one with 20L/min (4 UK gpm) flow and a second with an adjustable flow of 27-45L/min (6-10 UK gpm).
<b>Hydraulic Cylinders</b>	With hardened, chromed piston rods and end cushioning on boom, dipper and bucket crowd cylinder.
<b>Filtration</b>	
In tank	150 micron, suction strainer.
Main return line	10 micron, fibreform element.
Pilot line	10 micron, paper element.
Plexus by pass line	1.5 micron paper element.
Hydraulic hammer return	10 micron, reinforced microform element.

## TYRES

<b>Twins</b>	10.00 x 20 tyres (16PR) with spacer ring.
<b>Singles</b>	18R x 19.5 tyres (Radials).

## CAB

Excellent digging, loading and positioning visibility results from the careful design of front, side and roof lights. All screens are tinted to improve in cab conditions.

Fully opening front screen is very smooth to operate and the lower screen is stored in rear of cab.

Fresh air ventilation available from opening door window, opening slot in front screen and fully opening front screen.

Parallelogram wash wiper for upper screen ensuring good wiped area for maximum visibility. Wiper motor is fitted in the left hand side of the roof screen so as not to affect bucket visibility when loading. Optional lower screen wiper available.

Fresh air ventilation and heater with windscreen demister. Infinitely variable blower speed, temperature and recirculation control.

Climate control incorporating chilled cool box available as option. Fully adjustable deluxe suspension seat with arm rest adjustment and backrest recline. Radio with digital tuner fitted into the roof lining for maximum protection. Conveniently placed radio mute button incorporated into lower console. 12v power point and mobile phone holder built into the right hand console. Courtesy light can be operated from ground level and is illuminated for five minutes or until switched off improving operator access at night.

Cab mounted roller blind protects operator from suns'.

**AMS – ADVANCED MANAGEMENT SYSTEM**

Four selectable working modes link the operators control movements with the engine and hydraulic systems to maximise productivity and efficiency.

- A (Auto)** Up to 100% engine power and 100% flow. Gives variable power and speed depending on the operator's input, matching the demand for output and efficiency to the job. Power boost is automatically activated in this mode should hard conditions be encountered. Auto idle cuts in after a period of inactivity (between 5 and 30 seconds as set by the operator)
- E (Economy)** 80% engine power. 95% of hydraulic flow maximises economy while maintaining excellent output.
- P (Precision)** 55% engine power. 90% of hydraulic flow for fine control of grading operations.
- L (Lifting)** 55% engine power. 63% of hydraulic flow with permanent power boost for maximum lifting power and control.

The Auto mode allows the AMS processor to select the optimum operational performance to match the demands of the job while the three alternative modes give precise matching of application when specific tasks are undertaken.

The adjustable position monitor mounted on the front right hand pillar of the cab gives the operator a constant read out of mode, tracking range, operating temperature and a host of other information, while retaining excellent visibility of the monitor and the job being carried out.

The required flow for hammer applications can be set and stored in the AMS memory and is automatically activated whenever the hammer pedal is depressed.

A maintenance indicator warns of imminent service needs, and all servicing and basic checks can be carried out using only the in cab display.

**STANDARD EXCAVATING BUCKETS**

All buckets are JCB – Esco fully welded steel, with sealed, hardened steel pivot pins and replaceable wear parts.

Max Width mm (in.)	Capacity (SAE heaped) cu.m (cu.yd)	Weight kg (lb)
600 (24)	0.35 (0.46)	426 (937)
750 (30)	0.49 (0.64)	480 (1056)
900 (36)	0.62 (0.81)	525 (1155)
1000 (40)	0.72 (0.94)	564 (1240)
1200 (48)	0.90 (1.18)	633 (1392)

**SERVICE CAPACITIES**

	litres	UK gal
Fuel tank	310	68.19
Engine coolant	26	5.72
Engine oil	20.5	4.51
Swing reduction gear	2.2	0.5
Hydraulic system	124	27.3
Hydraulic tank	73	16.0
Transmission	2.5	0.55
Axle differentials (each)	Rear 12, Front 14	Rear 2.6, Front 3
Axle hubs (each)	2.0	0.5





### STANDARD EQUIPMENT

Engine fan guard; Cold start pre-heat; Auto engine warm up; Double element air cleaner; Heavy-duty alternator; Electrics isolator; Heavy-duty batteries; Cab & engine soundproofing; Cab heater & screen demister; Tinted glass; Interior light; Coat hook; Cigarette lighter; Ashtray; Operator's storage box; Removable floor mat; Windscreen wash/wipe; Plug-in power socket; Automatic power boost; Auto-idle; One-touch engine speed control; Hydraulic cushion control; Plexus hydraulic oil filtration; HSP pressure test points; Auxiliary pipework mounting brackets; Work lights – boom & mainframe mounted; Upper structure under covers; Swing system cover; External mirrors; Handrail & non slip walk ways; Quick connect engine oil drain pipe; Roof mounted blind; Quick connect fuel tank drain pipe; Single point creasing.

### OPTIONAL EQUIPMENT

Hose burst check valves & overload warning system; Tipping link mounted lift points; General purpose buckets; Ditch/grading buckets; Quickhitch buckets; Hydraulic hammers; Auxiliary pipework (full and low flow); Climate control; Cab mounted & rear work lights; Rotating beacon; Rain guard; Biodegradable oil; Air suspension seat with heated pad and lumbar support adjustment; Electric refuelling pump; Lower screen wiper; Radio; Cruise control; Grab stowage bar; FOPS (Level 2) operator protection; Biodegradable oil; High and low temperature oils; ROPS cab; immobiliser; LiveLink; 2F axles hub brakes; 2F axles wide hub brakes.

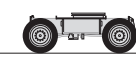
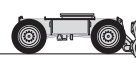
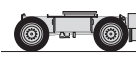
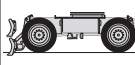
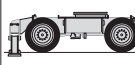
### OPERATING WEIGHTS

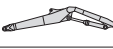
Chassis					
	15760kg (34745lb)	16200kg (35715lb)	16640kg (36685lb)	17180kg (37875lb)	17520kg (38625lb)
	16360kg (36068lb)	16800kg (37078lb)	17240kg (38008lb)	17780kg (39198lb)	18120kg (39948lb)

Machine equipped with excavating bucket and dual wheels. For single wheels subtract 400kg (880lb).



**LIFT CAPACITIES – Dipper Length: 2.25m, 5.15m Monoboom, Front dozer, Rear stabilisers, No bucket.**
**JS175W MONO**

Reach	1.5m (4ft 11in)		3m (9ft 10in)		4.5m (14ft 9in)		6m (19ft 8in)		7.5m (24ft 7in)		Capacity at Max Reach		
													mm
Load Point Ht.	kg	kg	kg	kg	kg	kg	kg	kg	kg	kg	kg	kg	mm
7.5m (24.7ft)					4360*	4360*						3830*	4620
6.0m (19.8ft)					5080*	5080*	3530*	3530*				3330*	6031
4.5m (14.9ft)					5710*	5710*	4890*	4120				3190*	6838
3.0m (9.10ft)					67440*	6170	5250*	3990				3230*	7248
1.5m (4.11ft)					7530*	5850	5580*	3840				3440*	7330
0m			5580*	5580*	7600*	5690	5600*	3750				3880*	7094
- 1.5m (- 4.11ft)	6310*	6310*	9440*	9440*	6950*	5670	5060*	3740				4400*	6508

**LIFT CAPACITIES – Dipper Length: 2.70m, 5.15m Monoboom, Front dozer, Rear stabilisers, No bucket.**
**JS175W MONO**

Reach	1.5m (4ft 11in)		3m (9ft 10in)		4.5m (14ft 9in)		6m (19ft 8in)		7.5m (24ft 7in)		Capacity at Max Reach		
													mm
Load Point Ht.	kg	kg	kg	kg	kg	kg	kg	kg	kg	kg	kg	kg	mm
7.5m (24.7ft)												2880*	5238
6.0m (19.8ft)							4040*	4040*				2580*	6514
4.5m (14.9ft)					5290*	5290*	4610*	4190				2500*	7266
3.0m (9.10ft)			9710*	9710*	6360*	6260	5040*	4030	3370*	2860		2540*	7653
1.5m (4.11ft)			5120*	5120*	7290*	5880	5450*	3860	4100*	2790		2690*	7731
0m			6660*	6660*	7590*	5660*	5600*	3740	3080*	2750		3020*	7508
- 1.5m (- 4.11ft)	6070*	6070*	10140*	10140*	7170*	5590	5280*	3690				3630*	6957
- 3.0m (- 9.10ft)	10160*	10160*	8130*	8130*	5930*	5660						4020*	5985
- 4.5m (- 14.9ft)			4570*	4570*								3120*	4307

**LIFT CAPACITIES – Dipper Length: 3.05m, 5.15m Monoboom, Front dozer, Rear stabilisers, No bucket.**
**JS175W MONO**

Reach	1.5m (4ft 11in)		3m (9ft 10in)		4.5m (14ft 9in)		6m (19ft 8in)		7.5m (24ft 7in)		Capacity at Max Reach		
													mm
Load Point Ht.	kg	kg	kg	kg	kg	kg	kg	kg	kg	kg	kg	kg	mm
7.5m (24.7ft)												2400*	5690
6.0m (19.8ft)							3840*	3840*				2170*	6881
4.5m (14.9ft)							4350*	4190	2500*	2500*		2110*	7596
3.0m (9.10ft)			8930*	8930*	6020*	6020*	4830*	4020	3790*	2840		2150*	7967
1.5m (4.11ft)			6790*	6790*	7070*	5920	5300*	3840	4330*	2760		2280*	8041
0m			6950*	6950*	7540*	5660	5540*	3710	4320*	2700		2540*	7828
- 1.5m (- 4.11ft)	5610*	5610*	9860*	9860*	7290*	5560	5350*	3650				3040*	7301
- 3.0m (- 9.10ft)	9050*	9050*	8780*	8780*	6260*	5600	4430*	3680				3920*	6383
- 4.5m (- 14.9ft)	7560*	7560*	5630*	5630*	3860*	3860*						3340*	4849



Lift capacity front and rear.



Lift capacity full circle.

**Notes:**

1. For lifting capacity including bucket, subtract total weight of bucket or bucket and quickhitch from above values.
2. Lifting capacities are based on ISO 10567, that is: 75% of minimum tipping load or 87% of hydraulic lift capacity, whichever is the less. Lifting capacities marked\* are based on hydraulic capacity.
3. Lift capacities assume that the machine is on firm, level ground.
4. Lift capacities may be limited by local regulations. Please refer to your dealer.



**LIFT CAPACITIES – Dipper Length: 2.25m, 5.15m Monoboom, Front and rear stabilisers, No bucket.**
**JS175W MONO**

Reach	1.5m (4ft 11in)		3m (9ft 10in)		4.5m (14ft 9in)		6m (19ft 8in)		7.5m (24ft 7in)		Capacity at Max Reach		
													mm
Load Point Ht.	kg	kg	kg	kg	kg	kg	kg	kg	kg	kg	kg	kg	mm
7.5m (24.7ft)					4360*	4360*					3830*	3830*	4620
6.0m (19.8ft)					5080*	5080*	3530*	3530*			3330*	3330*	6031
4.5m (14.9ft)					5710*	5710*	4890*	4670			3190*	3190*	6838
3.0m (9.10ft)					6740*	6740*	5250*	4530			3230*	3230*	7248
1.5m (4.11ft)					7530*	6760	5580*	4380			3440*	3270	7330
0m			5580*	5580*	7600*	6590	5600*	4290			3880*	3390	7094
- 1.5m (- 4.11ft)	6310*	6310*	9440*	9440*	6950*	6560	5060*	4270			4400*	3830	6508
- 3.0m (- 9.10ft)	8760*	8760*	7190*	7190*	5360*	5360*					4000*	4000*	5454
- 4.5m (- 14.9ft)			2810*	2810*							2280*	2280*	3524

**LIFT CAPACITIES – Dipper Length: 2.70m, 5.15m Monoboom, Front and rear stabilisers, No bucket.**
**JS175W MONO**

Reach	1.5m (4ft 11in)		3m (9ft 10in)		4.5m (14ft 9in)		6m (19ft 8in)		7.5m (24ft 7in)		Capacity at Max Reach		
													mm
Load Point Ht.	kg	kg	kg	kg	kg	kg	kg	kg	kg	kg	kg	kg	mm
7.5m (24.7ft)											2880*	2880*	5238
6.0m (19.8ft)							4040*	4040*			2580*	2580*	6514
4.5m (14.9ft)					5290*	5290*	4610*	4610*			2500*	2500*	7266
3.0m (9.10ft)			9710*	9710*	6360*	6360*	5040*	4570	3370*	3240	2540*	2540*	7653
1.5m (4.11ft)			5120*	5120*	7290*	6790	5450*	4400	4100*	3170	2690*	2690*	7731
0m			6660*	6660*	7590*	6560	5600*	4270	3080*	3080*	3020*	3020*	7508
- 1.5m (- 4.11ft)	6070*	6070*	10140*	10140*	7170*	6490	5280*	4230			3630*	3460	6957
- 3.0m (- 9.10ft)	10160*	10160*	8130*	8130*	5930*	5930*					4020*	4020*	5985
- 4.5m (- 14.9ft)			4570*	4570*							3120*	3120*	4307

**LIFT CAPACITIES – Dipper Length: 3.05m, 5.15m Monoboom, Front and rear stabilisers, No bucket.**
**JS175W MONO**

Reach	1.5m (4ft 11in)		3m (9ft 10in)		4.5m (14ft 9in)		6m (19ft 8in)		7.5m (24ft 7in)		Capacity at Max Reach			
													mm	
Load Point Ht.	kg	kg	kg	kg	kg	kg	kg	kg	kg	kg	kg	kg	mm	
7.5m (24.7ft)												2400*	2400*	5690
6.0m (19.8ft)							3840*	3840*				2170*	2170*	6881
4.5m (14.9ft)							4350*	4350*	2500*	2500*		2110*	2110*	7596
3.0m (9.10ft)			8930*	8930*	6020*	6020*	4830*	4570	3790*	3220		2150*	2150*	7967
1.5m (4.11ft)			6790*	6790*	7070*	6830	5300*	4390	4330*	3140		2280*	2280*	8041
0m			6950*	6950*	7540*	6560	5540*	4250	5320*	3080		2540*	2540*	7828
- 1.5m (- 4.11ft)	5610*	5610*	9860*	9860*	7290*	6460	5350*	4180				3040*	3040*	7301
- 3.0m (- 9.10ft)	9050*	9050*	8780*	8780*	6260*	6260*	4430*	4220				3920*	3880	6383
- 4.5m (- 14.9ft)	7560*	7560*	5630*	5630*	3860*	3860*						3340*	3340*	4849



Lift capacity front and rear.



Lift capacity full circle.

**Notes:**

1. For lifting capacity including bucket, subtract total weight of bucket or bucket and quickhitch from above values.
2. Lifting capacities are based on ISO 10567, that is: 75% of minimum tipping load or 87% of hydraulic lift capacity, whichever is the less. Lifting capacities marked\* are based on hydraulic capacity.
3. Lift capacities assume that the machine is on firm, level ground.
4. Lift capacities may be limited by local regulations. Please refer to your dealer.

**LIFT CAPACITIES – Dipper Length: 2.25m, 5.15m Monoboom, Rear stabilisers, No bucket.**
**JS175W MONO**

Reach	1.5m (4ft 11in)		3m (9ft 10in)		4.5m (14ft 9in)		6m (19ft 8in)		7.5m (24ft 7in)		Capacity at Max Reach		
													mm
Load Point Ht.	kg	kg	kg	kg	kg	kg	kg	kg	kg	kg	kg	kg	mm
7.5m (24.7ft)					4360*	4360*					3830*	3830*	4620
6.0m (19.8ft)					5080*	5080*	3530*	3280			3330*	3250	6031
4.5m (14.9ft)					5710*	5080	4890*	3240			3190*	2610	6838
3.0m (9.10ft)					6740*	4740	5250*	3110			3230*	2330	7248
1.5m (4.11ft)					7530*	4440	5530	2970			3440*	2230	7330
0m			5580*	5580*	7600*	4290	5420	2880			3880*	2300	7094
- 1.5m (- 4.11ft)	6310*	6310*	9440*	8140	6950*	4270	5060*	2870			4400*	2590	6508
- 3.0m (- 9.10ft)	8760*	8760*	7190*	7190*	5360*	4360					4000*	3370	5454
- 4.5m (- 14.9ft)			2810*	2810*							2280*	2280*	3524

**LIFT CAPACITIES – Dipper Length: 2.70m, 5.15m Monoboom, Rear stabilisers, No bucket.**
**JS175W MONO**

Reach	1.5m (4ft 11in)		3m (9ft 10in)		4.5m (14ft 9in)		6m (19ft 8in)		7.5m (24ft 7in)		Capacity at Max Reach		
													mm
Load Point Ht.	kg	kg	kg	kg	kg	kg	kg	kg	kg	kg	kg	kg	mm
7.5m (24.7ft)											2880*	2880*	5238
6.0m (19.8ft)							4040*	3370			2580*	2580*	6514
4.5m (14.9ft)					5290*	5190	4610*	3300			2500*	2400	7266
3.0m (9.10ft)			9710*	9060	6360*	4820	5040*	3140	3370*	2230	2540*	2150	7653
1.5m (4.11ft)			5120*	5120*	7290*	4460	5450*	2980	3930	2160	2690*	2070	7731
0m			6660*	6660*	7590*	4260	5410	2860	3080*	2120	3020*	2120	7508
- 1.5m (- 4.11ft)	6070*	6070*	10140*	7950	7170*	4200	5280*	2820			3630*	2340	6957
- 3.0m (- 9.10ft)	10160*	10160*	8130*	8110	5930*	4260					4020*	2910	5985
- 4.5m (- 14.9ft)			4570*	4570*							3120*	3120*	4307

**LIFT CAPACITIES – Dipper Length: 3.05m, 5.15m Monoboom, Rear stabilisers, No bucket.**
**JS175W MONO**

Reach	1.5m (4ft 11in)		3m (9ft 10in)		4.5m (14ft 9in)		6m (19ft 8in)		7.5m (24ft 7in)		Capacity at Max Reach			
													mm	
Load Point Ht.	kg	kg	kg	kg	kg	kg	kg	kg	kg	kg	kg	kg	mm	
7.5m (24.7ft)												2400*	2400*	5690
6.0m (19.8ft)							3840*	3380				2170*	2170*	6881
4.5m (14.9ft)							4350*	3290	2500*	2260		2110*	2110*	7596
3.0m (9.10ft)			8930*	8930*	6020*	4860	4830*	3140	3790*	2210		2150*	1990	7967
1.5m (4.11ft)			6790*	6790*	7070*	4490	5300*	2970	3900	2130		2280*	1910	8041
0m			6950*	6950*	7540*	4250	5390	2840	3830	2070		2540*	1950	7828
- 1.5m (- 4.11ft)	5610*	5610*	9860*	7910	7290*	4160	5320	2780				3040*	2140	7301
- 3.0m (- 9.10ft)	9050*	9050*	8780*	8040	6260*	4200	4430*	2810				3920*	2600	6383
- 4.5m (- 14.9ft)	7560*	7560*	5630*	5630*	3860*	3860*	3860*					3340*	3340*	4849



Lift capacity front and rear.



Lift capacity full circle.

**Notes:**

- For lifting capacity including bucket, subtract total weight of bucket or bucket and quickhitch from above values.
- Lifting capacities are based on ISO 10567, that is: 75% of minimum tipping load or 87% of hydraulic lift capacity, whichever is the less. Lifting capacities marked\* are based on hydraulic capacity.
- Lift capacities assume that the machine is on firm, level ground.
- Lift capacities may be limited by local regulations. Please refer to your dealer.

**LIFT CAPACITIES – Dipper Length: 2.25m, 5.15m Monoboom, Rear dozer blade, No bucket.**
**JS175W MONO**

Reach	1.5m (4ft 11in)		3m (9ft 10in)		4.5m (14ft 9in)		6m (19ft 8in)		7.5m (24ft 7in)		Capacity at Max Reach		
													mm
Load Point Ht.	kg	kg	kg	kg	kg	kg	kg	kg	kg	kg	kg	kg	mm
7.5m (24.7ft)					4360*	4360*					3830*	3830*	4620
6.0m (19.8ft)					5080*	5080*	3530*	2790			3330*	2760	6031
4.5m (14.9ft)					5710*	4300	4890*	2750			3190*	2210	6838
3.0m (9.10ft)					6740*	3970	5250*	2620			3230*	1960	7248
1.5m (4.11ft)					7530*	3690	5580*	2490			3440*	1870	7330
0m			5580*	5580*	7600*	3540	5600*	2400			3880*	1930	7094
- 1.5m (- 4.11ft)	6310*	6310*	9440*	6510	6950*	3520	5060*	2390			4400*	2170	6508
- 3.0m (- 9.10ft)	8760*	8760*	7190*	6680	5360*	3610					4000*	2810	5454
- 4.5m (- 14.9ft)			2810*	2810*							2280*	2280*	3524

**LIFT CAPACITIES – Dipper Length: 2.70m, 5.15m Monoboom, Rear dozer blade, No bucket.**
**JS175W MONO**

Reach	1.5m (4ft 11in)		3m (9ft 10in)		4.5m (14ft 9in)		6m (19ft 8in)		7.5m (24ft 7in)		Capacity at Max Reach		
													mm
Load Point Ht.	kg	kg	kg	kg	kg	kg	kg	kg	kg	kg	kg	kg	mm
7.5m (24.7ft)											2880*	2880*	5238
6.0m (19.8ft)							4040*	2880			2580	2480	6514
4.5m (14.9ft)					5290*	4400	4610*	2800			2500*	2030	7266
3.0m (9.10ft)			9710*	7360	6360*	4050	5040*	2660	3370*	1880	2540*	1810	7653
1.5m (4.11ft)			5120*	5120*	7290*	3710	5450*	2500	4100*	1810	2690*	1730	7731
0m			6660*	6310	7590*	3510	5600*	2390	3080*	1770	3020	1770	7508
- 1.5m (- 4.11ft)	6070*	6070*	10140*	6330	7170*	3450	5280*	2350			3630*	1950	6957
- 3.0m (- 9.10ft)	10160*	10160*	8130*	6490	5930*	3510					4020*	2430	5985
- 4.5m (- 14.9ft)			4570*	4570*							3120*	3120*	4307

**LIFT CAPACITIES – Dipper Length: 3.05m, 5.15m Monoboom, Rear dozer blade, No bucket.**
**JS175W MONO**

Reach	1.5m (4ft 11in)		3m (9ft 10in)		4.5m (14ft 9in)		6m (19ft 8in)		7.5m (24ft 7in)		Capacity at Max Reach		
													mm
Load Point Ht.	kg	kg	kg	kg	kg	kg	kg	kg	kg	kg	kg	kg	mm
7.5m (24.7ft)											2400*	2400*	5690
6.0m (19.8ft)							3840*	2880			2170*	2170*	6881
4.5m (14.9ft)							4350*	2800	2500*	1910	2110*	1860	7596
3.0m (9.10ft)			8930*	7600	6020*	4090	4830*	2650	3790*	1850	2150*	1670	7967
1.5m (4.11ft)			6790*	6650	7070*	3730	5300*	2480	4260	1780	2280*	1590	8041
0m			6950*	6330	7540*	3500	5540*	2360	4190	1720	2540*	1620	7828
- 1.5m (- 4.11ft)	5610*	5610*	9860*	6300	7290*	3420	5350*	2300			3040*	1780	7301
- 3.0m (- 9.10ft)	9050*	9050*	8780*	6410	6260*	3450	4430*	2330			3920*	2160	6383
- 4.5m (- 14.9ft)	7560*	7560*	5630*	5630*	3860*	3630					3340*	3290	4849



Lift capacity front and rear.



Lift capacity full circle.

**Notes:**

1. For lifting capacity including bucket, subtract total weight of bucket or bucket and quickhitch from above values.
2. Lifting capacities are based on ISO 10567, that is: 75% of minimum tipping load or 87% of hydraulic lift capacity, whichever is the less. Lifting capacities marked\* are based on hydraulic capacity.
3. Lift capacities assume that the machine is on firm, level ground.
4. Lift capacities may be limited by local regulations. Please refer to your dealer.

**LIFT CAPACITIES – Dipper Length: 2.25m, 4.98m T.A.B., Front dozer, rear stabilisers, No bucket.**
**JS175W T.A.B.**

Reach	1.5m (4ft 11in)		3m (9ft 10in)		4.5m (14ft 9in)		6m (19ft 8in)		7.5m (24ft 7in)		Capacity at Max Reach			
													mm	
Load Point Ht.	kg	kg	kg	kg	kg	kg	kg	kg	kg	kg	kg	kg	mm	
7.5m (24.7ft)												4240*	4240*	4492
6.0m (19.8ft)					4690*	4690*						3510*	3510*	5935
4.5m (14.9ft)			6720*	6720*	5250*	5250*	4630*	4190				3270*	3270*	6753
3.0m (9.10ft)					6270*	6270*	4990*	4050*				3230*	3060	7168
1.5m (4.11ft)					7190*	5960	5390*	3900				3350*	2960	7251
0m			5340*	5340*	7530*	5760	5540*	3800				3670*	3070	7013
- 1.5m (- 4.11ft)			10110*	10110*	7130*	5730	5140*	3790				4330*	3480	6419
- 3.0m (- 9.10ft)					5670*	5670*						5100*	5100*	4882

**LIFT CAPACITIES – Dipper Length: 2.70m, 4.98m T.A.B., Front dozer, rear stabilisers, No bucket.**
**JS175W T.A.B.**

Reach	1.5m (4ft 11in)		3m (9ft 10in)		4.5m (14ft 9in)		6m (19ft 8in)		7.5m (24ft 7in)		Capacity at Max Reach			
													mm	
Load Point Ht.	kg	kg	kg	kg	kg	kg	kg	kg	kg	kg	kg	kg	mm	
7.5m (24.7ft)					4410*	4410*						3120*	3120*	5155
6.0m (19.8ft)					4240*	4240*	4170*	4170*				2700*	2700*	6448
4.5m (14.9ft)					4820*	4820*	4330*	4270				2550*	2550*	7207
3.0m (9.10ft)			8730*	8730*	5870*	5870*	4750*	4100	3200*	2890		2530*	2530*	7597
1.5m (4.11ft)					6900*	6000	5220*	3920	3880*	2820		2630*	2630*	7675
0m			6410*	6410*	7430*	5740	5490*	3790				2870*	2810	7451
- 1.5m (- 4.11ft)			10500*	10500*	7270*	5660	5330*	3740				3340*	3120	6895
- 3.0m (- 9.10ft)			8830*	8830*	6230*	5740						4150*	3930	5913

**LIFT CAPACITIES – Dipper Length: 3.05m, 4.98m T.A.B., Front dozer, rear stabilisers, No bucket.**
**JS175W T.A.B.**

Reach	1.5m (4ft 11in)		3m (9ft 10in)		4.5m (14ft 9in)		6m (19ft 8in)		7.5m (24ft 7in)		Capacity at Max Reach			
													mm	
Load Point Ht.	kg	kg	kg	kg	kg	kg	kg	kg	kg	kg	kg	kg	mm	
7.5m (24.7ft)												2580*	2580*	5629
6.0m (19.8ft)							3860*	3860*				2270*	2270*	6831
4.5m (14.9ft)					4440*	4440*	4050*	4050*	2430*	2430*		2150*	2150*	7551
3.0m (9.10ft)			7950*	7950*	5520*	5520*	4520*	4110	3790*	2870		2140*	2140*	7924
1.5m (4.11ft)			6890*	6890*	6650*	6040	5040*	3910	4210*	2790		2230*	2230*	7998
0m			6710*	6710*	7320*	5750	5400*	3760	4210*	2730		2420*	2420*	7784
- 1.5m (- 4.11ft)	5120*	5120*	9850*	9850*	7330*	5630	5370*	3690				2800*	2800*	7254
- 3.0m (- 9.10ft)			9410*	9410*	6530*	5670	4540*	3740				3590*	3500	6329

Lift capacity front and rear.

Lift capacity full circle.

**Notes:**

1. For lifting capacity including bucket, subtract total weight of bucket or bucket and quickhitch from above values.
2. Lifting capacities are based on ISO 10567, that is: 75% of minimum tipping load or 87% of hydraulic lift capacity, whichever is the less. Lifting capacities marked\* are based on hydraulic capacity.
3. Lift capacities assume that the machine is on firm, level ground.
4. Lift capacities may be limited by local regulations. Please refer to your dealer.

**LIFT CAPACITIES – Dipper Length: 2.25m, 4.98m T.A.B., Front and rear stabilisers, No bucket.**
**JS175W T.A.B.**

Reach	1.5m (4ft 11in)		3m (9ft 10in)		4.5m (14ft 9in)		6m (19ft 8in)		7.5m (24ft 7in)		Capacity at Max Reach		
											kg	kg	mm
Load Point Ht.	kg	kg											
7.5m (24.7ft)											4240*	4240*	4492
6.0m (19.8ft)					4690*	4690*					3510*	3510*	5935
4.5m (14.9ft)			6720*	6720*	5250*	5250*	4630*	4630*			3270*	3270*	6753
3.0m (9.10ft)					6270*	6270*	4990*	4610			3230*	3230*	7168
1.5m (4.11ft)					7190*	6890	5390*	4460			3350*	3350*	7251
0m			5340*	5340*	7530*	6690	5540*	4350			3670*	3500	7013
- 1.5m (- 4.11ft)			10110*	10110*	7130*	6650	5140*	4340			4330*	3970	6419
- 3.0m (- 9.10ft)					5670*	5670*					5100*	5100*	4882

**LIFT CAPACITIES – Dipper Length: 2.70m, 4.98m T.A.B., Front and rear stabilisers, No bucket.**
**JS175W T.A.B.**

Reach	1.5m (4ft 11in)		3m (9ft 10in)		4.5m (14ft 9in)		6m (19ft 8in)		7.5m (24ft 7in)		Capacity at Max Reach		
											kg	kg	mm
Load Point Ht.	kg	kg											
7.5m (24.7ft)					4410*	4410*					3120*	3120*	5155
6.0m (19.8ft)					4240*	4240*	4170*	4170*			2700*	2700*	6448
4.5m (14.9ft)					4820*	4820*	4330*	4330*			2550*	2550*	7207
3.0m (9.10ft)			8730*	8730*	5870*	5870*	4750*	4670	3200*	3200*	2530*	2530*	7597
1.5m (4.11ft)					6900*	6900*	5220*	4480	3880*	3220	2630*	2630*	7675
0m			6410*	6410*	7430*	6670	5490*	4340			2870*	2870*	7451
- 1.5m (- 4.11ft)			10500*	10500*	7270*	6580	5330*	4290			3340*	3340*	6895
- 3.0m (- 9.10ft)			8830*	8830*	6230*	6230*					4150*	4150*	5913

**LIFT CAPACITIES – Dipper Length: 3.05m, 4.98m T.A.B., Front and rear stabilisers, No bucket.**
**JS175W T.A.B.**

Reach	1.5m (4ft 11in)		3m (9ft 10in)		4.5m (14ft 9in)		6m (19ft 8in)		7.5m (24ft 7in)		Capacity at Max Reach		
											kg	kg	mm
Load Point Ht.	kg	kg											
7.5m (24.7ft)											2580*	2580*	5629
6.0m (19.8ft)							3860*	3860*			2270*	2270*	6831
4.5m (14.9ft)					4440*	4440*	4050*	4050*	2430*	2430*	2150*	2150*	7551
3.0m (9.10ft)			7950*	7950*	5520*	5520*	4520*	4520*	3790*	3270	2140*	2140*	7924
1.5m (4.11ft)			6890*	6890*	6650*	6650*	5040*	4470	4210*	3190	2230*	2230*	7998
0m			6710*	6710*	7320*	6670	5400*	4320	4210*	3120	2420*	2420*	7784
- 1.5m (- 4.11ft)	5120*	5120*	9850*	9850*	7330*	6550	5370*	4250			2800*	2800*	7254
- 3.0m (- 9.10ft)			9410*	9410*	6530*	6530*	4540*	4300			3590*	3590*	6329



Lift capacity front and rear.



Lift capacity full circle.

**Notes:**

1. For lifting capacity including bucket, subtract total weight of bucket or bucket and quickhitch from above values.
2. Lifting capacities are based on ISO 10567, that is: 75% of minimum tipping load or 87% of hydraulic lift capacity, whichever is the less. Lifting capacities marked\* are based on hydraulic capacity.
3. Lift capacities assume that the machine is on firm, level ground.
4. Lift capacities may be limited by local regulations. Please refer to your dealer.

**LIFT CAPACITIES – Dipper Length: 2.25m, 4.98m T.A.B., Rear stabilisers, No bucket.**
**JS175W T.A.B.**

Reach	1.5m (4ft 11in)		3m (9ft 10in)		4.5m (14ft 9in)		6m (19ft 8in)		7.5m (24ft 7in)		Capacity at Max Reach			
													kg	mm
Load Point Ht.	kg	kg	kg	kg	kg	kg	kg	kg	kg	kg	kg	kg	kg	mm
7.5m (24.7ft)												4240*	4240*	4492
6.0m (19.8ft)					4690*	4690*						3510*	3350	5935
4.5m (14.9ft)			6720*	6720*	5250*	5200	4630*	3280				3270*	2670	6753
3.0m (9.10ft)					6270*	4840	4990*	3150				3230*	2370	7168
1.5m (4.11ft)					7190*	4510	5390*	3000				3350*	2280	7251
0m			5340*	5340*	7530*	4330	5540	2900				3670*	2360	7013
- 1.5m (- 4.11ft)			10110*	8180	7130*	4300	5140*	2900				4330*	2670	6419
- 3.0m (- 9.10ft)					5670*	4410						5100*	3940	4882

**LIFT CAPACITIES – Dipper Length: 2.70m, 4.98m T.A.B., Rear stabilisers, No bucket.**
**JS175W T.A.B.**

Reach	1.5m (4ft 11in)		3m (9ft 10in)		4.5m (14ft 9in)		6m (19ft 8in)		7.5m (24ft 7in)		Capacity at Max Reach			
													kg	mm
Load Point Ht.	kg	kg	kg	kg	kg	kg	kg	kg	kg	kg	kg	kg	kg	mm
7.5m (24.7ft)					4410*	4410*						3120*	3120*	5155
6.0m (19.8ft)					4240*	4240*	4170*	3410				2700*	2700*	6448
4.5m (14.9ft)					4820*	4820*	4330*	3350				2550*	2440	7207
3.0m (9.10ft)			8730*	8730*	5870*	4940	4750*	3190	3200*	2240		2530*	2190	7597
1.5m (4.11ft)					6900*	4540	5220*	3020	3880*	2180		2630*	2100	7675
0m			6410*	6410*	7430*	4300	5490*	2890				2870*	2160	7451
- 1.5m (- 4.11ft)			10500*	8000	7270*	4230	5330*	2850				3340*	2400	6895
- 3.0m (- 9.10ft)			8830*	8180	6230*	4300						4150*	3010	5913

**LIFT CAPACITIES – Dipper Length: 3.05m, 4.98m T.A.B., Rear stabilisers, No bucket.**
**JS175W T.A.B.**

Reach	1.5m (4ft 11in)		3m (9ft 10in)		4.5m (14ft 9in)		6m (19ft 8in)		7.5m (24ft 7in)		Capacity at Max Reach			
													kg	mm
Load Point Ht.	kg	kg	kg	kg	kg	kg	kg	kg	kg	kg	kg	kg	kg	mm
7.5m (24.7ft)												2580*	2580*	5629
6.0m (19.8ft)							3860*	3430				2270*	2270*	6831
4.5m (14.9ft)					4440*	4440*	4050*	3360	2430*	2270		2150*	2150*	7551
3.0m (9.10ft)			7950*	7950*	5520*	4990	4520*	3190	3790*	2220		2140*	2010	7924
1.5m (4.11ft)			6890*	6890*	6650*	4580	5040*	3010	3980	2150		2230*	1940	7998
0m			6710*	6710*	7320*	4310	5400*	2870	3910	2090		2420*	1980	7784
- 1.5m (- 4.11ft)	5120*	5120*	9850*	7960	7330*	4200	5370*	2800				2800*	2180	7254
- 3.0m (- 9.10ft)			9410*	8100	6530*	4230	4540*	2850				3590*	2680	6329

Lift capacity front and rear.

Lift capacity full circle.

**Notes:**

1. For lifting capacity including bucket, subtract total weight of bucket or bucket and quickhitch from above values.
2. Lifting capacities are based on ISO 10567, that is: 75% of minimum tipping load or 87% of hydraulic lift capacity, whichever is the less. Lifting capacities marked\* are based on hydraulic capacity.
3. Lift capacities assume that the machine is on firm, level ground.
4. Lift capacities may be limited by local regulations. Please refer to your dealer.

**LIFT CAPACITIES – Dipper Length: 2.25m, 4.98m T.A.B., Rear dozer blade, No bucket.**
**JS175W T.A.B.**

Reach	1.5m (4ft 11in)		3m (9ft 10in)		4.5m (14ft 9in)		6m (19ft 8in)		7.5m (24ft 7in)		Capacity at Max Reach		
											kg	kg	mm
Load Point Ht.	kg	kg											
7.5m (24.7ft)											4240*	4240*	4492
6.0m (19.8ft)					4690*	4590					3510*	2840	5935
4.5m (14.9ft)			6720*	6720*	5250*	4390	4630*	2780			3270*	2250	6753
3.0m (9.10ft)					6270*	4050	4990*	2650			3230*	1990	7168
1.5m (4.11ft)					7190*	3730	5390*	2510			3350*	1900	7251
0m			5340*	5340*	7530*	3560	5540*	2410			3670*	1960	7013
- 1.5m (- 4.11ft)			10110*	6520	7130*	3530	5140*	2400			4330*	2220	6419
- 3.0m (- 9.10ft)					5670*	3640					5100*	3260	4882

**LIFT CAPACITIES – Dipper Length: 2.70m, 4.98m T.A.B., Rear dozer blade, No bucket.**
**JS175W T.A.B.**

Reach	1.5m (4ft 11in)		3m (9ft 10in)		4.5m (14ft 9in)		6m (19ft 8in)		7.5m (24ft 7in)		Capacity at Max Reach		
											kg	kg	mm
Load Point Ht.	kg	kg	kg	kg	kg	kg	kg	kg	kg	kg	kg	kg	mm
7.5m (24.7ft)					4410*	4410*					3120*	3120*	5155
6.0m (19.8ft)					4240*	4240*	4170*	2900			2700*	2520	6448
4.5m (14.9ft)					4820*	4510	4330*	2840			2550*	2050	7207
3.0m (9.10ft)			8730*	7610	5870*	4140	4750*	2690	3200*	1870	2530*	1830	7597
1.5m (4.11ft)					6900*	3760	5220*	2520	3880*	1810	2630*	1750	7675
0m			6410*	6340	7430*	3530	5490*	2400			2870*	1790	7451
- 1.5m (- 4.11ft)			10500*	6340	7270*	3460	5330*	2360			3340*	1990	6895
- 3.0m (- 9.10ft)			8830*	6510	6230*	3530					4150*	2500	5913

**LIFT CAPACITIES – Dipper Length: 3.05m, 4.98m T.A.B., Rear dozer blade, No bucket.**
**JS175W T.A.B.**

Reach	1.5m (4ft 11in)		3m (9ft 10in)		4.5m (14ft 9in)		6m (19ft 8in)		7.5m (24ft 7in)		Capacity at Max Reach		
											kg	kg	mm
Load Point Ht.	kg	kg	kg	kg	kg	kg	kg	kg	kg	kg	kg	kg	mm
7.5m (24.7ft)											2580*	2580*	5629
6.0m (19.8ft)							3860*	2920			2270*	2270	6831
4.5m (14.9ft)					4440*	4440*	4050*	2850	2430*	1900	2150*	1870	7551
3.0m (9.10ft)			7950*	7860	5520*	4190	4520*	2690	3790*	1860	2140*	1680	7924
1.5m (4.11ft)			6890*	6790	6650*	3800	5040*	2510	4210*	1780	2230*	1600	7998
0m			6710*	6370	7320*	3530	5400*	2370	4210*	1730	2420*	1640	7784
- 1.5m (- 4.11ft)	5120*	5120*	9850*	6310	7330*	3430	5370*	2310			2800*	1800	7254
- 3.0m (- 9.10ft)			9410*	6430	6530*	3460	4540*	2360			3590*	2220	6329



Lift capacity front and rear.



Lift capacity full circle.

**Notes:**

1. For lifting capacity including bucket, subtract total weight of bucket or bucket and quickhitch from above values.
2. Lifting capacities are based on ISO 10567, that is: 75% of minimum tipping load or 87% of hydraulic lift capacity, whichever is the less. Lifting capacities marked\* are based on hydraulic capacity.
3. Lift capacities assume that the machine is on firm, level ground.
4. Lift capacities may be limited by local regulations. Please refer to your dealer.

## A GLOBAL COMMITMENT TO QUALITY

JCB's total commitment to its products and customers has helped it grow from a one-man business into Britain's largest privately owned manufacturer of backhoe loaders, crawler excavators, wheeled excavators, telescopic handlers, wheeled loaders, dump trucks, rough terrain fork lifts, industrial fork lifts, mini/midi excavators, skid steer loaders, tractors and compaction equipment.

By making constant and massive investments in the latest production technology, the JCB factories have become some of the most advanced in the world.

By leading the field in innovative research and design, extensive testing and stringent quality control, JCB machines have become renowned all over the world for performance, value and reliability.

And with a global sales and service network of more than 650 dealers and agents, we aim to deliver the best customer support in the industry.

Through setting the standards by which others are judged, JCB has become one of the world's most impressive success stories.



JCB Sales Limited, Rokester, Staffordshire ST14 5JP. Tel: 01889 590312. Fax: 01889 590588. Web: <http://www.jcb.com>

JCB reserves the right to change specifications without notice. Illustrations shown may include optional equipment and accessories. The JCB logo is a registered trademark of J C Bamford Excavators Ltd.



9999/4982 03/12 Issue 6